

VACON[®] 20
AC DRIVES

QUICK GUIDE

VAGON[®]

This quick guide includes the essential steps for easy installation and setup of your Vacon 20 frequency converter. Before commissioning your drive, download and read the complete Vacon 20 User Manual available at:

<http://drives.danfoss.com/knowledge-center/technical-documentation/>

1. SAFETY



ONLY A COMPETENT ELECTRICIAN IS ALLOWED TO CARRY OUT THE ELECTRICAL INSTALLATION!

This quick guide contains clearly marked warnings which are intended for your personal safety and to avoid any unintentional damage to the product or connected appliances.

Please read these warnings carefully:



The components of the power unit of the frequency converter are live when Vacon 20 is connected to mains. Coming into contact with this voltage is extremely dangerous and may cause death or severe injury.



The motor terminals U, V, W (T1, T2, T3) and the possible brake resistor terminals - / + are live when Vacon 20 is connected to mains, even if the motor is not running.



The control I / O-terminals are isolated from the mains potential. However, the relay output terminals may have a dangerous control voltage present even when Vacon 20 is disconnected from mains.



The earth leakage current of Vacon 20 frequency converters exceeds 3.5 mA AC. According to standard EN61800-5-1, a reinforced protective ground connection must be ensured. **See Chapter 7!**



If the frequency converter is used as a part of a machine, the machine manufacturer is responsible for providing the machine with a main switch [EN 60204-1].



If Vacon 20 is disconnected from mains while running the motor, it remains live if the motor is energized by the process. In this case the motor functions as a generator feeding energy to the frequency converter.



After disconnecting the frequency converter from the mains, wait until the fan stops and the display segments or status leds on the front panel go out. Wait 5 more minutes before doing any work on Vacon 20 connections.



The motor can start automatically after a fault situation, if the autoreset function has been activated.

NOTE! You can download the English and French product manuals with applicable safety, warning and caution information from <http://drives.danfoss.com/knowledge-center/technical-documentation/>.

REMARQUE Vous pouvez télécharger les versions anglaise et française des manuels produit contenant l'ensemble des informations de sécurité, avertissements et mises en garde applicables sur le site <http://drives.danfoss.com/knowledge-center/technical-documentation/>.

2. INSTALLATION

2.1 Mechanical installation

There are two possible ways to mount Vacon 20 in the wall. For MI1 - MI3, either screw or DIN-rail mounting; For MI4 - MI5, screw or flange mounting.

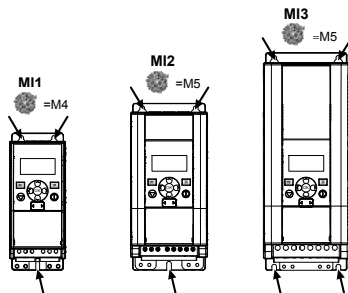

Figure 1: Screw mounting, MI1 - MI3

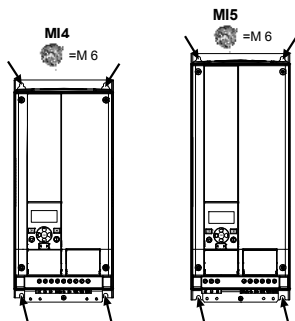

Figure 2: Screw mounting, MI4 - MI5

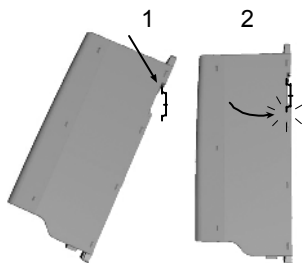

Figure 3: DIN-rail mounting, MI1 - MI3

Note! See the mounting dimensions on the back of the drive. Leave **free space** for cooling above (**100 mm**), below (**50 mm**), and on the sides (**20 mm**) of Vacon 20! (For MI1 - MI3, side-to-side installation allowed only if the ambient temperature is below 40 °C; For MI4 - MI5, side-to-side installation is not allowed.)

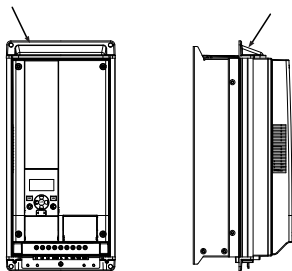

Figure 4: flange mounting, MI4 - MI5

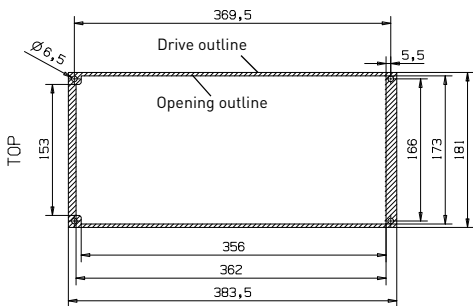

Figure 5: Flange mounting cutout dimensions for MI4 (Unit: mm)

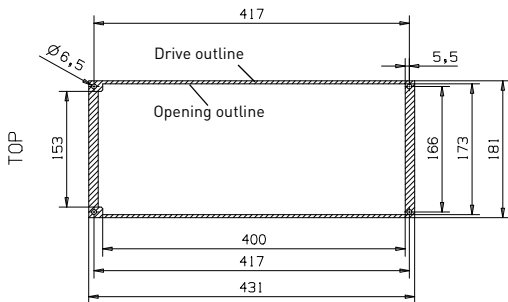

Figure 6: Flange mounting cutout dimensions for MI5 (Unit: mm)

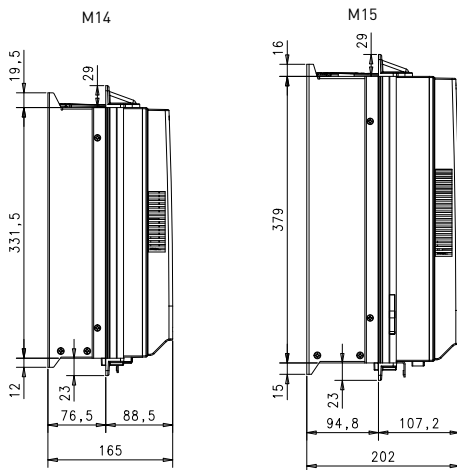

Figure 7: Flange mounting depth dimensions for M14 and M15 (Unit: mm)

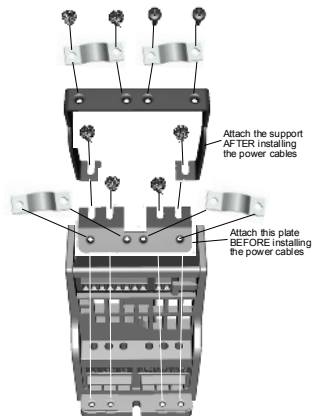

Figure 8: Attaching the PE-plate and API cable support, MI1 - MI3

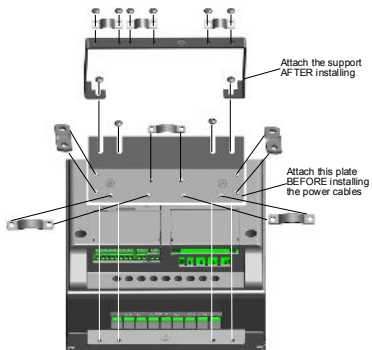

Figure 9: Attaching the PE-plate and API cable support, MI4 - MI5

2.2 Cabling and connections

2.2.1 Power cabling

Note! Tightening torque for power cables is 0.5 - 0.6 Nm (4-5 in.lbs).

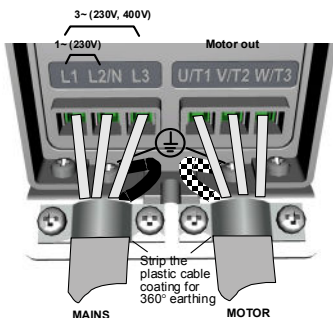

Figure 10: Vacon 20 power connections, MI1

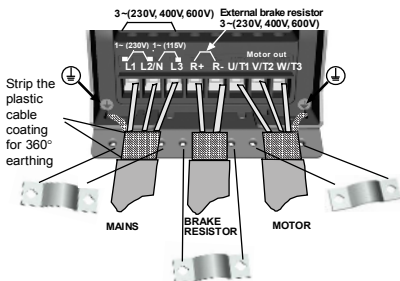

Figure 11: Vacon 20 power connections, MI2 - MI3

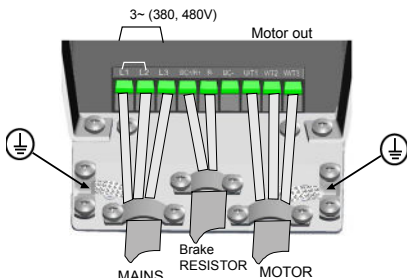

Figure 12: Vacon 20 power connections, MI4

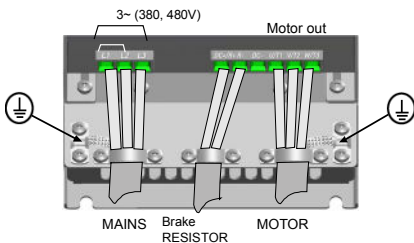

Figure 13: Vacon 20 power connections, MI5

2.2.2 Control cabling

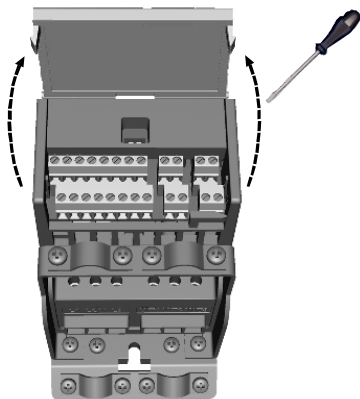

Figure 14: Open the lid MI1 - MI3

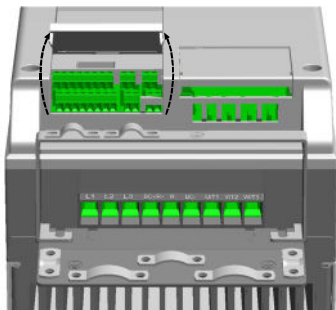

Figure 15: Open the lid MI4 - MI5

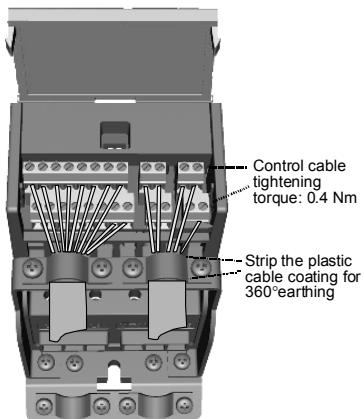

Figure 16: Install the control cables, MI1 - MI3

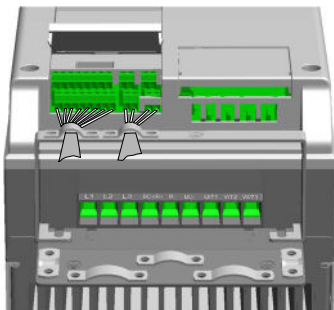

Figure 17: Install the control cables, MI4 - MI5

2.2.3 Allowed option boards in Vacon20

See below for the allowed option boards in the slot:

SLOT	EC	E3	E5	E6	E7	E9	B1	B2	B4	B5	B9	BH	BF
------	----	----	----	----	----	----	----	----	----	----	----	----	----

Note! When OPT-B1 / OPT-B4 used in Vacon20, +24VDC ($\pm 10\%$, min.300mA) power should be supplied to Terminal 6 (+24_out) and Terminal 3 (GND) in control board.

Option boards (all boards are varnished)	
OPT-EC-V	EtherCat
OPT-E3-V	Profibus DPV1 (Screw connector)
OPT-E5-V	Profibus DPV1 (D9 connector)
OPT-E6-V	CANopen
OPT-E7-V	DeviceNet
OPT-E9-V	Modbus TCP, Profinet & Ethernet IP
OPT-B1-V	6 x DI/DO, each I/O can be individually
OPT-B2-V	2 x Relay output + Thermistor
OPT-B4-V	1 x AI, 2 x AO (isolated)
OPT-B5-V	3 x Relay output
OPT-B9-V	1 x RO, 5 x DI (42-240 VAC)
OPT-BH-V	3 x Temperature measurement (support for PT100, PT1000, NI1000, KTY84-130, KTY84-150, KTY84-131 sensors)
OPT-BF-V	1 x AO, 1 x DO, 1 x RO

Option board assembly structure:

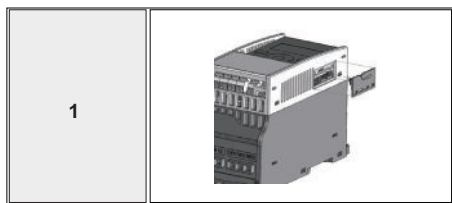

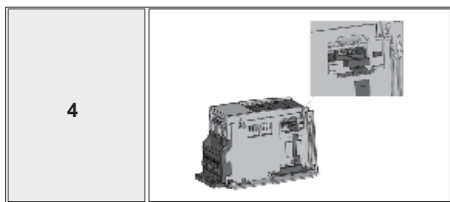
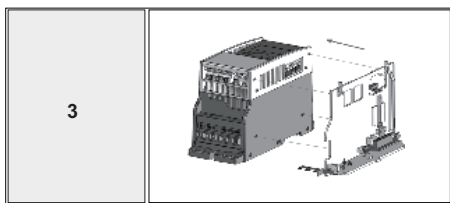
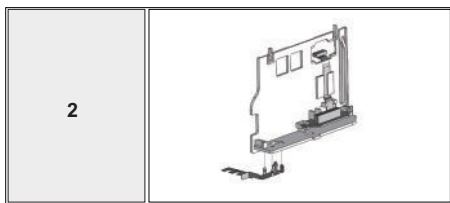

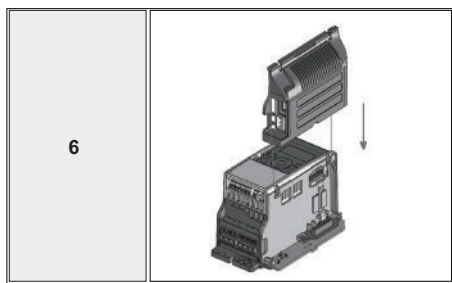
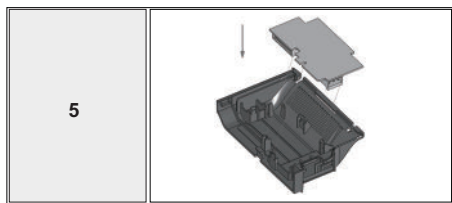

3. CONTROL I / O AND TERMINALS

Vacon 20



Terminal	Signal	Factory preset	Description	
1	+10 Vref		Ref voltage out Maximum load 10 mA	
2	AI1	Freq reference ^{P1}	0 - 10 V, Ri = 250 kΩ	
3	GND		I / O signal ground	
6	24 Vout		24 V output for DI's ±20%, max load 50 mA	
7	DI_C		Digital Input Common Digital Input for DI1- DI6, refer to Table 2 for DI sink type	
8	DI1	Start forward ^{P1}	Positive, Logic1: 18...30V, Logic0: 0...5V; Negative, Logic1: 0...10V, Logic0: 18...30V; Ri = 10KΩ (floating)	
9	DI2	Start reverse ^{P1}		
10	DI3	Fault reset ^{P1}		
A	A	RS485 signal A	FB Communication	Negative
B	B	RS485 signal B	FB Communication	Positive
4	AI2	PID actual value and Freq reference ^{P1}	Default: 0(4) - 20 mA, Ri ≤ 250 Ω Other: 0 - 10 V, Ri = 250 kΩ Selectable through microswitch	
5	GND		I / O signal ground	
13	DO-		Digital Output Common	
14	DI4	Preset speed B0 ^{P1}	AS DI1	
15	DI5	Preset speed B1 ^{P1}	As DI1, Other: Encoder Input A [frequency up to 10 kHz] Selectable through microswitch	
16	DI6	External Fault ^{P1}	As DI1, Other: Encoder Input B [frequency up to 10 kHz], Pulse Train Input [frequency up to 5 kHz]	
18	A0	Output frequency ^{P1}	0 - 10 V, RL ≥ 1 KΩ 0(4) - 20 mA, RL ≤ 500 Ω Selectable through microswitch	
20	DO	Active = READY ^{P1}	Open collector, max load 35 V / 50 mA	

Table 1: Vacon 20 General purpose application default I / O configuration and connections for control board

^{P1}) = Programmable function, See User Manual: parameter lists and descriptions for detail

Terminal	Signal	Factory preset	Description
22	RO1 NO	Active = RUN ^{P1}	Switching load: 250 Vac / 3 A, 24V DC 3A
23	RO1 CM		
24	RO2 NC	Active = FAULT ^{P1}	Switching load: 250 Vac / 3 A, 24V DC 3A
25	RO2 CM		
26	RO2 NO		

Table 1: Vacon 20 General purpose application default I / O configuration and connections for control board
P) = Programmable function, See User Manual: parameter lists and descriptions for detail

Terminal	Signal	Factory preset	Description
3	GND	I / O signal ground	
6	24 Vout	24 V output for DI's	±20 %, max load 50 mA
7	DI_C	Digital Input Common	Digital Input Common for DI1-DI6
8	DI1	Digital input 1	Start forward ^{P1}
9	DI2	Digital input 2	Start reverse ^{P1}
10	DI3	Digital input 3	Fault reset ^{P1}
14	DI4	Digital input 4	Preset speed B0 ^{P1}
15	DI5	Digital input 5	Preset speed B1 ^{P1}
16	DI6	Digital input 6	External Fault ^{P1}

Table 2: DI Sink Type, remove jumper J500 and connect the wire using table 2

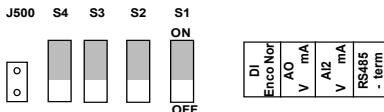
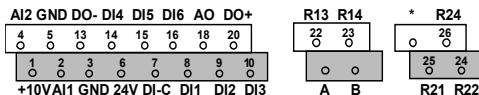

Figure 18: Microswitches

Vacon 20 I / O terminals:



4. NAVIGATION AND STARTUP

4.1 The main menus of Vacon 20

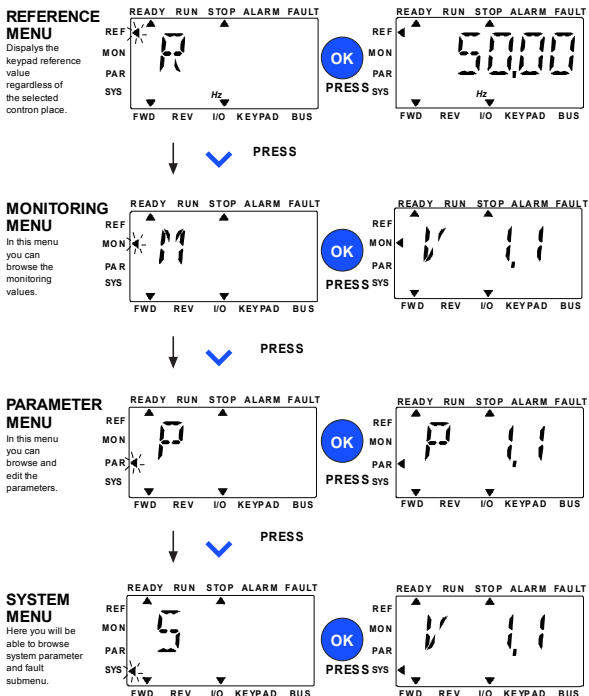

Figure 19: The main menu of Vacon 20

4.2 Commissioning and startup wizard

4.2.1 Commissioning steps:

1. Read safety instructions on page 1	7. Perform test run without motor , see the User Manual at http://drives.danfoss.com/knowledge-center/technical-documentation/
2. Secure the grounding and check that cables comply with requirements	8. Run no-load tests without motor being connected to the process
3. Check quality and quantity of cooling air	9. Perform an identification run [Par. ID631]
4. Check that all start / stop switches are in STOP position	10. Connect the motor to the process and perform test run once again
5. Connect the drive to mains	11. Vacon 20 is now ready for use
6. Run the Startup wizard and set all necessary parameters	

Table 3: Commissioning steps

4.2.2 Startup wizard

Vacon 20 runs the startup wizard in first power-up. The wizard can be run by setting SYS Par.4.2 =1. The following figures show the procedure.

NOTE! Running the startup wizard will always return all parameter settings to their factory defaults!

NOTE! StartUp-Wizard can be skipped after pressing STOP button continuously for 30 seconds

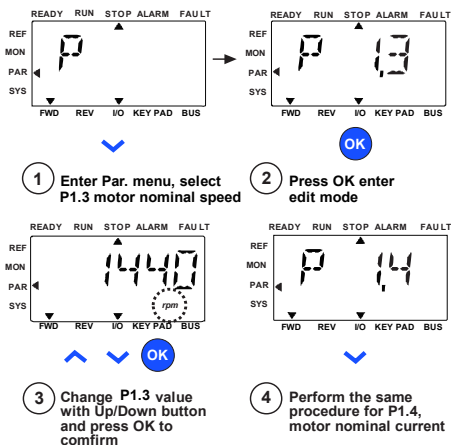
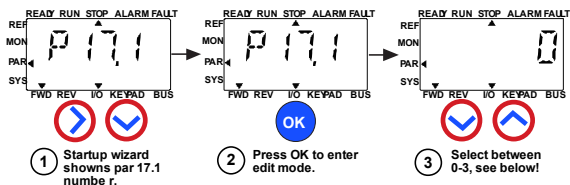

Figure 20: Vacon 20 startup wizard (standard application)



Selections:

	P1.7	P1.8	P1.15	P2.2	P2.3	P3.1	P4.2	P4.3
0 = Basic	1.5 x INMOT	0= Frequency control	0= Not used	0= Ramp	0= Coast	0 Hz	3s	3s
1 = Pump drive	1.1 x INMOT	0= Frequency control	0= Not used	0= Ramp	1= Ramp	20 Hz	5s	5s
2 = Fan drive	1.1 x INMOT	0= Frequency control	0= Not used	1= Flying	0= Coast	20 Hz	20s	20s
3 = High Torque drive	1.5 x INMOT	1= Open loop speed control	1= used	0= Ramp	0= Coast	0 Hz	1s	1s

Parameters affected:

P1.7	Current limit (A)	P2.3	Stop function
P1.8	Motor control mode	P3.1	Min frequency
P1.15	Torque boost	P4.2	Acc. time (s)
P2.2	Start function	P4.3	Dec time (s)

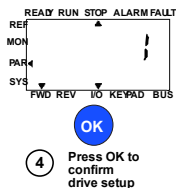

Figure 21: Drive setup

5. MONITORING AND PARAMETERS

NOTE! This guide is for Vacon 20 standard application, if you need parameter descriptions for detail, please download the user manual on: <http://drives.danfoss.com/knowledge-center/technical-documentation/>.

5.1 Monitoring values

Code	Monitoring signal	Unit	ID	Description
V1.1	Output frequency	Hz	1	Output frequency to motor
V1.2	Frequency reference	Hz	25	Frequency reference to motor control
V1.3	Motor speed	rpm	2	Calculated motor speed
V1.4	Motor current	A	3	Measured motor current
V1.5	Motor torque	%	4	Calculated actual / nominal torque of the motor
V1.6	Motor shaft power	%	5	Calculated actual / nominal power of the motor
V1.7	Motor voltage	V	6	Motor voltage
V1.8	DC-link voltage	V	7	Measured DC-link voltage
V1.9	Unit temperature	°C	8	Heatsink temperature
V1.10	Motor temperature	%	9	Calculated motor temperature
V1.11	Output Power	KW	79	Output power from drive to motor
V2.1	Analogue input 1	%	59	A11 signal range in percent of used range
V2.2	Analogue input 2	%	60	A12 signal range in percent of used range
V2.3	Analogue output	%	81	A0 signal range in percent of used range
V2.4	Digital input status DI1, DI2, DI3		15	Digital input status
V2.5	Digital input status DI4, DI5, DI6		16	Digital input status
V2.6	R01, R02, D0		17	Relay / digital output status
V2.7	Pulse train / encoder input	%	1234	0 - 100% scale value
V2.8	Encoder rpm	rpm	1235	Scaled according to Encoder pulses / revolution parameter

Table 4: Monitoring values

Code	Monitoring signal	Unit	ID	Description
V2.11	Analogue input E1	%	61	Analogue input signal 1 in % from option board, hidden until an option board is connected
V2.12	Analogue output E1	%	31	Analogue output signal 1 in % from option board, hidden until an option board is connected
V2.13	Analogue output E2	%	32	Analogue output signal 2 in % from option board, hidden until an option board is connected
V2.14	DIE1, DIE2, DIE3		33	This monitor value shows status of the digital inputs 1-3 from option board, hidden until an option board is connected
V2.15	DIE4, DIE5, DIE6		34	This monitor value shows status of the digital inputs 4-6 from option board, hidden until an option board is connected
V2.16	DOE1,DOE2,DOE3		35	This monitor value shows status of the relay outputs 1-3 from option board, hidden until an option board is connected
V2.17	DOE4,DOE5,DOE6		36	This monitor value shows status of the relay outputs 4-6 from option board, hidden until an option board is connected
V2.18	Temperature input 1		50	Measured value of Temperature input 1 in temperature unit (Celsius or Kelvin) by parameter setting, hidden until an option board is connected
V2.19	Temperature input 2		51	Measured value of Temperature input 2 in temperature unit (Celsius or Kelvin) by parameter setting, hidden until an option board is connected
V2.20	Temperature input 3		52	Measured value of Temperature input 3 in temperature unit (Celsius or Kelvin) by parameter setting, hidden until an option board is connected

Table 4: Monitoring values

Code	Monitoring signal	Unit	ID	Description
V3.1	Drive status word		43	Bit codes status of drive B0 = Ready B1 = Run B2 = Reverse B3 = Fault B6 = RunEnable B7 = AlarmActive B12 = RunRequest B13 = MotorRegulatorActive
V3.2	Application status word		89	Bit codes status of application: B3 = Ramp 2 Active B5 = Remote CTRL Place 1 active B6 = Remote CTRL Place 2 active B7 = Fieldbus Control Active B8 = Local Control Active B9 = PC Control Active B10 = Preset Frequencies Active
V3.3	DIN status word		56	B0 = DI1 B1 = DI2 B2 = DI3 B3 = DI4 B4 = DI5 B5 = DI6 B6 = DIE1 B7 = DIE2 B8 = DIE3 B9 = DIE4 B10 = DIE5 B11 = DIE6
V4.1	PID set point	%	20	Regulator setpoint
V4.2	PID feedback value	%	21	Regulator actual value
V4.3	PID error	%	22	Regulator error
V4.4	PID output	%	23	Regulator output
V4.5	Process		29	Scaled process variable see par. 15.18

Table 4: Monitoring values

5.2 Quick setup parameters (Virtual menu, shows when par. 17.2 = 1)

Code	Parameter	Min	Max	Unit	Default	ID	Note
P1.1	Motor nominal voltage	180	690	V	Varies	110	Check rating plate on the motor.
P1.2	Motor nominal frequency	30.00	320.00	Hz	50.00 / 60.00	111	Check rating plate on the motor.
P1.3	Motor nominal speed	30	20000	rpm	1440 / 1720	112	Default applies for a 4-pole motor.
P1.4	Motor nominal current	0.2 x I _{Nunit}	2.0 x I _{Nunit}	A	I _{Nunit}	113	Check rating plate on the motor.
P1.5	Motor cos ϕ	0.30	1.00		0.85	120	Check rating plate on the motor.
P1.7	Current limit	0.2 x I _{Nunit}	2.0 x I _{Nunit}	A	1.5 x I _{Nunit}	107	Maximum motor current
P1.15	Torque boost	0	1		0	109	0 = Not used 1 = Used
P2.1	Remote control place 1 selection	0	2		0	172	0 = I / O terminal 1 = Fieldbus 2 = Keypad
P2.2	Start function	0	1		0	505	0 = Ramp 1 = Flying start
P2.3	Stop function	0	1		0	506	0 = Coasting 1 = Ramp
P3.1	Min frequency	0.00	P3.2	Hz	0.00	101	Minimum freq reference
P3.2	Max frequency	P3.1	320.00	Hz	50.00 / 60.00	102	Maximum freq reference
P3.3	Remote Control Place 1 frequency reference selection	1	Varies		7	117	1 = Preset speed 0 2 = Keypad 3 = Fieldbus 4 = AI1 5 = AI2 6 = PID 7 = AI1 + AI2 8 = Motor potentiometer 9 = Pulse train / Encoder 10 = AIE1 11 = Temperature input 1 12 = Temperature input 2 13 = Temperature input 3 Note: Pay attention to DI/Encoder switch position when set with 9=Pulse train / Encoder

Table 5: Quick setup parameters

Code	Parameter	Min	Max	Unit	Default	ID	Note
P3.4	Preset speed 0	P3.1	P3.2	Hz	5.00	180	Preset speed 0 is used as frequency reference when P3.3 = 1
P3.5	Preset speed 1	P3.1	P3.2	Hz	10.00	105	Activated by digital inputs
P3.6	Preset speed 2	P3.1	P3.2	Hz	15.00	106	Activated by digital inputs
P3.7	Preset speed 3	P3.1	P3.2	Hz	20.00	126	Activated by digital inputs
P4.2	Acceleration time 1	0.1	3000.0	s	3.0	103	Acceleration time from 0 Hz to maximum frequency.
P4.3	Deceleration time 1	0.1	3000.0	s	3.0	104	Deceleration time from maximum frequency to 0 Hz.
P6.1	AI1 Signal range	0	1		0	379	0 = 0 - 100% 1 = 20% - 100% 20% is the same as 2 V minimum signal level.
P6.5	AI2 Signal range	0	1		0	390	0 = 0 - 100% 1 = 20% - 100% 20% is the same as 2 V or 4 mA minimum signal level.
P14.1	Automatic reset	0	1		0	731	0 = Disable 1 = Enable
P17.2	Parameter conceal	0	1		1	115	0 = All parameters visible 1 = Only quick setup parameter group visible

Table 5: Quick setup parameters

5.3 Motor settings (Control panel: Menu PAR -> P1)

Code	Parameter	Min	Max	Unit	Default	ID	Note
P1.1	Motor nominal voltage	180	690	V	Varies	110	Check rating plate on the motor
P1.2	Motor nominal frequency	30.0 0	320.0 0	Hz	50.00 / 60.00	111	Check rating plate on the motor
P1.3	Motor nominal speed	30	20000	rpm	1440 / 1720	112	Default applies for a 4-pole motor.
P1.4	Motor nominal current	0.2 x I_{Nunit}	2.0 x I_{Nunit}	A	I_{Nunit}	113	Check rating plate on the motor
P1.5	Motor cos φ (Power Factor)	0.30	1.00		0.85	120	Check rating plate on the motor
P1.6	Motor type	0	1		0	650	0 = Induction 1 = Permanent magnet
P1.7	Current limit	0.2 x I_{Nunit}	2.0 x I_{Nunit}	A	1.5 x I_{Nunit}	107	Maximum motor current
P1.8	Motor control mode	0	1		0	600	0 = Frequency control 1 = Open loop speed control
P1.9	U / f ratio	0	2		0	108	0 = Linear 1 = Square 2 = Programmable
P1.10	Field weakening point	8.00	320.0 0	Hz	50.00 / 60.00	602	Field weakening point frequency
P1.11	Field weakening point voltage	10.0 0	200.0 0	%	100.00	603	Voltage at field weakening point as % of U_{nmot}
P1.12	U / f mid point frequency	0.00	P1.10	Hz	50.00 / 60.00	604	Mid point frequency for programmable U / f
P1.13	U / f mid point voltage	0.00	P1.11	%	100.00	605	Mid point voltage for programmable U / f as % of U_{nmot}
P1.14	Zero freq voltage	0.00	40.00	%	Varies	606	Voltage at 0 Hz as % of U_{nmot}
P1.15	Torque Boost	0	1		0	109	0 = Disabled 1 = Enabled
P1.16	Switching frequency	1.5	16.0	kHz	4.0 / 2.0	601	PWM frequency. If values are higher than default, reduce the current capacity

Table 6: Motor settings

Code	Parameter	Min	Max	Unit	Default	ID	Note
P1.17	Brake Chopper	0	2		0	504	0 = Disabled 1 = Enabled: Always 2 = Run state
P1.18	Brake chopper level	0	911	V	varies	1267	Brake chopper control activation level in volt. For 240V Supply: 240*1.35*1.18 = 382V For 400V Supply: 400*1.35*1.18 = 638V Please note that when brake chopper is used the overvoltage controller can be switched off or the overvoltage reference level can be set above the brake chopper level.
P1.19	Motor identification	0	2		0	631	0 = Not active 1 = Standstill identification (need run command within 20 s to activate) 2 = Identification with run (need run command within 20 s to activate. Only available in power SW V026 included in FW01070V010 or later version)
P1.20	Rs voltage drop	0.00	100.00	%	0.00	662	Voltage drop over motor windings as % of U_{nmot} at nominal current.
P1.21	Overvoltage controller	0	2		1	607	0 = Disabled 1 = Enabled, Standard mode 2 = Enabled, Shock load mode
P1.22	Undervoltage controller	0	1		1	608	0 = Disable 1 = Enable
P1.23	Sine filter	0	1		0	522	0 = Not in use 1 = In use

Table 6: Motor settings

Code	Parameter	Min	Max	Unit	Default	ID	Note
P1.24	Modulator type**	0	65535		28928	648	Modulator configuration word: B1 = Discontinuous modulation (DPWMMIN) B2 = Pulse dropping in overmodulation B6 = Under modulation B8 = Instantaneous DC voltage compensation * B11 = Low noise B12 = Dead time compensation * B13 = Flux error compensation * * Enabled by default
P1.25	Efficiency optimization*	0	1		0	666	Energy optimization, the frequency converter search for the minimum cuuren in order to save energy and lower motor noise 0 = disabled 1 = enable
P1.26	I/f start enable*	0	1		0	534	0 = disabled 1 = enable
P1.27	I/f start frequency reference limit*	1	100	%	10	535	Output frequency limit below which the defined I/f start current is fed to motor.
P1.28	I/f start current reference*	0	100.0	%	80.0	536	Current reference in percent of motor nominal current [1 = 0.1%]
P1.29	Voltage limiter enable*	0	1		1	1079	Select voltage limiter mode: 0 = Disabled 1 = Enabled
P1.30	Start delay time	0	16.00	s	0	1499	NOTE! The delay time between run request is given and drive go to running. 0 = not used

Table 6: Motor settings

NOTE!

* These parameters are only available in power SW FWP00001V026 included in FW0107V010 or later version.

** Not more visible in version FW0107V012.

NOTE! These parameters are shown, when P17.2 = 0.

5.4 Start / stop setup (Control panel: Menu PAR -> P2)

Code	Parameter	Min	Max	Unit	Default	ID	Note
P2.1	Remote Control Place Selection	0	2		0	172	0 = I / O terminals 1 = Fieldbus 2 = Keypad
P2.2	Start function	0	1		0	505	0 = Ramp 1 = Flying start
P2.3	Stop function	0	1		0	506	0 = Coasting 1 = Ramp
P2.4	I / O Start / Stop logic	0	4		2	300	I / O control signal 1 I / O control signal 2 0 Forward Reverse 1 Fwd(edge) Inverted Stop 2 Fwd(edge) Bwd(edge) 3 Start Reverse 4 Start(edge) Reverse
P2.5	Local / Remote	0	1		0	211	0 = Remote control 1 = Local control
P2.6	Keypad control direction	0	1		0	123	0 = Forward 1 = Reverse
P2.7	Keypad stop button	0	1		1	114	0 = Keypad control only 1 = Always
P2.8	Remote Control Place 2 Selection	0	2		0	173	0 = I / O terminals 1 = Fieldbus 2 = Keypad
P2.9	keypad button lock	0	1		0	15520	0 = unlock all keypad button 1 = Loc/Rem button locked
P2.10	Keypad reverse enable	0	1		0	1500	0 = Reverse enabled 1 = Reverse disabled

Table 7: Start / stop setup

5.5 Frequency references (Control panel: Menu PAR -> P3)

Code	Parameter	Min	Max	Unit	Default	ID	Note
P3.1	Min frequency	0.00	P3.2	Hz	0.00	101	Minimum allowed frequency reference
P3.2	Max frequency	P3.1	320.00	Hz	50.00 / 60.00	102	Maximum allowed frequency reference
P3.3	Remote Control Place 1 frequency reference selection	1	Varies		7	117	1 = Preset speed 0 2 = Keypad 3 = Fieldbus 4 = AI1 5 = AI2 6 = PID 7 = AI1 + AI2 8 = Motor potentiometer 9 = Pulse train / Encoder 10 = AIE1 11 = Temperature input 1 12 = Temperature input 2 13 = Temperature input 3 Note: Pay attention to DI/Encoder switch position when set with 9=Pulse train / Encoder
P3.4	Preset speed 0	P3.1	P3.2	Hz	5.00	180	Preset speed 0 is used as frequency reference when P3.3 = 1
P3.5	Preset speed 1	P3.1	P3.2	Hz	10.00	105	Activated by digital inputs
P3.6	Preset speed 2	P3.1	P3.2	Hz	15.00	106	Activated by digital inputs
P3.7	Preset speed 3	P3.1	P3.2	Hz	20.00	126	Activated by digital inputs
P3.8	Preset speed 4	P3.1	P3.2	Hz	25.00	127	Activated by digital inputs
P3.9	Preset speed 5	P3.1	P3.2	Hz	30.00	128	Activated by digital inputs
P3.10	Preset speed 6	P3.1	P3.2	Hz	40.00	129	Activated by digital inputs
P3.11	Preset speed 7	P3.1	P3.2	Hz	50.00	130	Activated by digital inputs
P3.12	Remote Control Place 2 frequency reference selection	1	Varies		5	131	See P3.3
P3.13	Motor Potentiometer Ramp	1	50	Hz/s	5	331	Speed variation rate
P3.14	Motor Potentiometer Reset	0	2		2	367	0 = No Reset 1 = Reset if stopped 2 = Reset if powered down

Table 8: Frequency references

NOTE! These parameters are shown, when P17.2 = 0.

5.6 Ramps and brakes setup (Control panel: Menu PAR -> P4)

Code	Parameter	Min	Max	Unit	Default	ID	Note
P4.1	Ramp S-shape 1	0.0	10.0	s	0.0	500	0 = Linear >0 = S-curve ramp time
P4.2	Acceleration time 1	0.1	3000.0	s	3.0	103	Defines the time required for the output frequency to increase from zero frequency to maximum frequency.
P4.3	Deceleration time 1	0.1	3000.0	s	3.0	104	Defines the time required for the output frequency to decrease from maximum frequency to zero frequency.
P4.4	Ramp S-shape 2	0.0	10.0	s	0.0	501	See the parameter P4.1
P4.5	Acceleration time 2	0.1	3000.0	s	10.0	502	See the parameter P4.2
P4.6	Deceleration time 2	0.1	3000.0	s	10.0	503	See the parameter P4.3
P4.7	Flux Braking	0	3		0	520	0 = Off 1 = Deceleration 2 = Chopper 3 = Full Mode
P4.8	Flux Braking Current	0.5 x I_{Nunit}	2.0 x I_{Nunit}	A	I_{Nunit}	519	Defines the current level for flux braking.
P4.9	DC Braking Current	0.3 x I_{Nunit}	2.0 x I_{Nunit}	A	I_{Nunit}	507	Defines the current injected into the motor during DC braking.
P4.10	Stop DC current time	0.00	600.00	s	0.00	508	Determines if braking is ON or OFF and the braking time of the DC-brake when the motor is stopping. 0.00 = Not active
P4.11	Stop DC current frequency	0.10	10.00	Hz	1.50	515	The output frequency at which the DC-braking is applied.
P4.12	Start DC current time	0.00	600.00	s	0.00	516	0.00 = Not active

Table 9: Ramps and brakes setup

Code	Parameter	Min	Max	Unit	Default	ID	Note
P4.13	Accel2 Frequency Threshold	0.00	P3.2	Hz	0.00	527	0.00 = disabled
P4.14	Decel2 Frequency Threshold	0.00	P3.2	Hz	0.00	528	0.00 = disabled
P4.15	External Brake: Open Delay	0.00	320.00	s	0.20	1544	Delay to open brake after Open frequency limit is reached.
P4.16	External Brake: Open Frequency limit	0.00	P3.2	Hz	1.50	1535	Opening frequency from forward and reverse direction.
P4.17	External Brake : Close Frequency limit	0.00	P3.2	Hz	1.00	1539	Close frequency from positive direction if no run command active.
P4.18	External Brake : Close Frequency limit in Reverse	0.00	P3.2	Hz	1.50	1540	Close frequency from negative direction if no run command active.
P4.19	External Brake : Open/Close Current limit	0.0	200.0	%	20.0	1585	The brake is not opened if the current does not exceed this value, and is closed immediately if current goes below. This parameter is set as a percent of Motor nominal current.
P4.20	Quick stop deceleration time	0,1	3000,0	s	2,0	1259	Deceleration time for quick stop (for digin or fieldbus)

Table 9: Ramps and brakes setup

5.7 Digital inputs (Control panel: Menu PAR -> P5)

Code	Parameter	Min	Max	Unit	Default	ID	Note
P5.1	I/O control signal 1	0	Varies		1	403	0 = Not used 1 = DI1 2 = DI2 3 = DI3 4 = DI4 5 = DI5 6 = DI6 7 = DIE1 8 = DIE2 9 = DIE3 10 = DIE4 11 = DIE5 12 = DIE6
P5.2	I/O control signal 2	0	Varies		2	404	See 5.1
P5.3	Reverse	0	Varies		0	412	See 5.1
P5.4	Ext. fault Close	0	Varies		6	405	See 5.1
P5.5	Ext. fault Open	0	Varies		0	406	See 5.1
P5.6	Fault reset	0	Varies		3	414	See 5.1
P5.7	Run enable	0	Varies		0	407	See 5.1
P5.8	Preset speed B0	0	Varies		4	419	See 5.1
P5.9	Preset speed B1	0	Varies		5	420	See 5.1
P5.10	Preset speed B2	0	Varies		0	421	See 5.1
P5.11	Ramp time 2 selection	0	Varies		0	408	See 5.1
P5.12	Motor potentiometer up	0	Varies		0	418	See 5.1
P5.13	Motor potentiometer down	0	Varies		0	417	See 5.1
P5.14	Remote control place 2	0	Varies		0	425	Activates control place 2 See 5.1
P5.15	Remote control place freq reference 2	0	Varies		0	343	Activates control place 2 See parameter 5.1
P5.16	PID setpoint 2	0	Varies		0	1047	Activates reference 2 See 5.1

Table 10: Digital inputs

Code	Parameter	Min	Max	Unit	Default	ID	Note
P5.17	Motor Preheat Active	0	Varies		0	1044	Activates the Motor Preheat (DC-Current) in stop state when parameter Motor Preheat function is set to 2 See 5.1
P5.18	Quick stop open	0	Varies		0	1213	As parameter 5.1

Table 10: Digital inputs

5.8 Analogue inputs (Control panel: Menu PAR -> P6)

Code	Parameter	Min	Max	Unit	Default	ID	Note
P6.1	AI1 Signal range	0	1		0	379	0 = 0 - 100% (0 - 10 V) 1 = 20% - 100% (2 - 10 V)
P6.2	AI1 Custom min	-100.00	100.00	%	0.00	380	0.00 = no min scaling
P6.3	AI1 Custom max	-100.00	300.00	%	100.00	381	100.00 = no max scaling
P6.4	AI1 filter time	0.0	10.0	s	0.1	378	0 = no filtering
P6.5	AI2 signal range	0	1		0	390	See P6.1
P6.6	AI2 Custom min	-100.00	100.00	%	0.00	391	See P6.2
P6.7	AI2 Custom max	-100.00	300.00	%	100.00	392	See P6.3
P6.8	AI2 filter time	0.0	10.0	s	0.1	389	See P6.4
P6.9	AIE1 Signal range	0	1		0	143	See P6.1, hidden until an option board is connected
P6.10	AIE1 Custom Min	-100.00	100.00	%	0.00	144	See P6.2, hidden until an option board is connected
P6.11	AIE1 Custom Max	-100.00	300.00	%	100.00	145	See P6.3, hidden until an option board is connected
P6.12	AIE1 Filter time	0.0	10.0	s	0.1	142	See P6.4, hidden until an option board is connected

Table 11: Analogue inputs

5.9 Pulse train / Encoder (Control panel: Menu PAR -> P7)

Code	Parameter	Min	Max	Unit	Default	ID	Note
P7.1	Min pulse frequency	0	10000	Hz	0	1229	Pulse frequency to be interpreted as a 0% signal.
P7.2	Max pulse frequency	0.0	10000	Hz	10000	1230	Pulse frequency to be interpreted as a 100% signal.
P7.3	Freq ref at min pulse freq	0.00	P3.2	Hz	0.00	1231	Frequency corresponding to 0% if used as frequency reference.
P7.4	Freq ref at max pulse freq	0.00	P3.2	Hz	50.00 / 60.00	1232	Frequency corresponding to 100% if used as frequency reference.
P7.5	Encoder direction	0	2		0	1233	0 = Disable 1 = Enable / Normal 2 = Enable / Inverted
P7.6	Encoder pulses / revolution	1	65535	ppr	256	629	Pulse count of encoder per round. Used for scaling encoder rpm monitor value only.
P7.7	Config DI5 and DI6	0	2		0	1165	0 = DI5 and DI6 are for normal digital input 1 = DI6 is for pulse train 2 = DI5 and DI6 are for encoder frequency mode

Table 12: Pulse train/Encoder

5.10 Digital outputs (Control panel: Menu PAR -> P8)

Code	Parameter	Min	Max	Unit	Default	ID	Selections
P8.1	RO1 signal selection	0	Varies		2	313	0 = Not used 1 = Ready 2 = Run 3 = Fault 4 = Fault Inverted 5 = Warning 6 = Reversed 7 = At Speed 8 = Motor regulator active 9 = FB Control Word.B13 10 = FB Control Word.B14 11 = FB Control Word.B15 12 = Output freq superv. 13 = Output torque superv. 14 = Unit temperature superv. 15 = Analogue input superv. 16 = Preset Speed Active 17 = External Brake ctrl 18 = Keypad control active 19 = I / O control active 20 = Temperature supervision
P8.2	RO2 signal selection	0	Varies		3	314	See 8.1
P8.3	DO1 signal selection	0	Varies		1	312	See 8.1
P8.4	RO2 inversion	0	1		0	1588	0 = No inversion 1 = Inverted
P8.5	RO2 ON delay	0.00	320.00	s	0.00	460	0.00 = No delay
P8.6	RO2 OFF delay	0.00	320.00	s	0.00	461	0.00 = No delay
P8.7	RO1 inversion	0	1		0	1587	0 = No inversion 1 = Inverted
P8.8	RO1 ON delay	0.00	320.00	s	0.00	458	0.00 = No delay
P8.9	RO1 OFF delay	0.00	320.00	s	0.00	459	0.00 = No delay
P8.10	DOE1 signal selection	0	Varies		0	317	See 8.1, hidden until an option board is connected
P8.11	DOE2 signal selection	0	Varies		0	318	See 8.1, hidden until an option board is connected
P8.12	DOE3 signal selection	0	Varies		0	1386	See 8.1, hidden until an option board is connected

Table 13: Digital outputs

Code	Parameter	Min	Max	Unit	Default	ID	Selections
P8.13	DOE4 signal selection	0	Varies		0	1390	See 8.1, hidden until an option board is connected
P8.14	DOE5 signal selection	0	Varies		0	1391	See 8.1, hidden until an option board is connected
P8.15	DOE6 signal selection	0	Varies		0	139	See 8.1, hidden until an option board is connected

Table 13: Digital outputs

5.11 Analogue outputs (Control panel: Menu PAR -> P9)

Code	Parameter	Min	Max	Unit	Default	ID	Selections
P9.1	Analogue output signal selection	0	14		1	307	0 = Not used 1 = Output freq ($0-f_{max}$) 2 = Output current ($0-I_{nMotor}$) 3 = Motor torque ($0-T_{nMotor}$) 4 = PID output (0 - 100%) 5 = Freq refer. ($0-f_{max}$) 6 = Motor speed ($0-n_{max}$) 7 = Motor power ($0-P_{nMotor}$) 8 = Motor Voltage ($0-U_{nMotor}$) 9 = DC-link Voltage (0 - 1000 V) 10 = Process Data In1 (0 - 10000) 11 = Process Data In2 (0 - 10000) 12 = Process Data In3 (0 - 10000) 13 = Process Data In4 (0 - 10000) 14 = Test 100%
P9.2	Analogue output minimum	0	1		0	310	0 = 0 V / 0 mA 1 = 2 V / 4 mA
P9.3	Analogue output scaling	0.0	1000.0	%	100.0	311	Scaling factor
P9.4	Analogue output filter time	0.00	10.00	s	0.10	308	Filter time
P9.5	Analogue output E1 signal selection	0	14		0	472	See P9.1, hidden until an option board is connected
P9.6	Analogue output E1 minimum	0	1		0	475	See P9.2, hidden until an option board is connected

Table 14: Analogue outputs

Code	Parameter	Min	Max	Unit	Default	ID	Selections
P9.7	Analogue output E1 scaling	0.0	1000.0	%	100.0	476	See P9.3, hidden until an option board is connected
P9.8	Analogue output E1 filter time	0.00	10.00	s	0.10	473	See P9.4, hidden until an option board is connected
P9.9	Analogue output E2 signal selection	0	14		0	479	See P9.1, hidden until an option board is connected
P9.10	Analogue output E2 minimum	0	1		0	482	See P9.2, hidden until an option board is connected
P9.11	Analogue output E2 scaling	0.0	1000.0	%	100.0	483	See P9.3, hidden until an option board is connected
P9.12	Analogue output E2 filter time	0.00	10.00	s	0.10	480	See P9.4, hidden until an option board is connected

Table 14: Analogue outputs

5.12 Fieldbus Data-Mapping (Control panel: Menu PAR -> P10)

Code	Parameter	Min	Max	Unit	Default	ID	Note
P10.1	FB Data Output 1 selection	0	Varies		0	852	0 = Frequency reference 1 = Output reference 2 = Motor speed 3 = Motor current 4 = Motor voltage 5 = Motor torque 6 = Motor power 7 = DC link voltage 8 = Active fault code 9 = Analogue AI1 10 = Analogue AI2 11 = Digital input state 12 = PID feedback value 13 = PID setpoint 14 = Pulse train / encoder input(%) 15 = Pulse train / encoder pulse() 16 = AIE1
P10.2	FB Data Output 2 selection	0	Varies		1	853	Variable mapped on PD2
P10.3	FB Data Output 3 selection	0	Varies		2	854	Variable mapped on PD3
P10.4	FB Data Output 4 selection	0	Varies		4	855	Variable mapped on PD4
P10.5	FB Data Output 5 selection	0	Varies		5	856	Variable mapped on PD5
P10.6	FB Data Output 6 selection	0	Varies		3	857	Variable mapped on PD6
P10.7	FB Data Output 7 selection	0	Varies		6	858	Variable mapped on PD7
P10.8	FB Data Output 8 selection	0	Varies		7	859	Variable mapped on PD8
P10.9	Aux CW Data In selection	0	5		0	1167	PDI for Aux CW 0 = Not used 1 = PDI1 2 = PDI2 3 = PDI3 4 = PDI4 5 = PDI5

Table 15: Fieldbus Data-Mapping

5.13 Prohibited Frequencies (Control panel: Menu PAR -> P11)

Code	Parameter	Min	Max	Unit	Default	ID	Note
P11.1	Prohibit Frequency Range 1 Low Limit	0.00	P3.2	Hz	0.00	509	Low Limit 0.00 = Not used
P11.2	Prohibit Frequency Range 1 High Limit	0.00	P3.2	Hz	0.00	510	High Limit 0.00 = Not used
P11.3	Prohibit Frequency Range 2 Low Limit	0.00	P3.2	Hz	0.00	511	Low Limit 0.00 = Not used
P11.4	Prohibit Frequency Range 2 High Limit	0.00	P3.2	Hz	0.00	512	High Limit 0.00 = Not used

Table 16: Prohibited Frequencies

5.14 Limit Supervisions (Control panel: Menu PAR -> P12)

Code	Parameter	Min	Max	Unit	Default	ID	Note
P12.1	Output freq supervision function	0	2		0	315	0 = Not used 1 = Low limit 2 = High limit
P12.2	Output freq supervision limit	0.00	P3.2	Hz	0.00	316	Output frequency supervision threshold
P12.3	Torque supervision function	0	2		0	348	0 = Not used 1 = Low limit 2 = High limit
P12.4	Torque supervision limit	0.0	300.0	%	0.0	349	Torque supervision Threshold
P12.5	Unit Temperature Supervision	0	2		0	354	0 = Not used 1 = Low limit 2 = High limit
P12.6	Unit Temperature Supervision Limit	-10	100	°C	40	355	Unit temperature supervision threshold
P12.7	Analogue input superv signal	0	Varies		0	356	0 = AI1 1 = AI2 2 = AIE1
P12.8	AI superv ON level	0.00	100.00	%	80.00	357	ON threshold AI superv.
P12.9	AI superv OFF level	0.00	100.00	%	40.00	358	OFF threshold AI superv.

Table 17: Limit Supervisions

Code	Parameter	Min	Max	Unit	Default	ID	Note
P12.10	Temperature supervision input	1	7		1	1431	Binary-coded selection of signals to use for temperature supervision B0 = Temperature input 1 B1 = Temperature input 2 B2 = Temperature input 3 NOTE! Hidden until an option board is connected
P12.11	Temperature supervision function	0	2		2	1432	See 12.1, hidden until an option board is connected
P12.12	Temperature supervision limit	-50.0/ 223.2	200.0/ 473.2		80.0	1433	Temperature supervision threshold, hidden until an option board is connected

Table 17: Limit Supervisions

5.15 Protections (Control panel: Menu PAR -> P13)

Code	Parameter	Min	Max	Unit	Default	ID	Note
P13.1	Analogue Input low fault	0	4		1	700	0 = No action 1 = Alarm 2 = Alarm, preset alarm frequency 3 = Fault: Stop function 4 = Fault: Coast
P13.2	Under voltage fault	1	2		2	727	1 = No response (no fault generated but drive still stops modulation) 2 = Fault: Coast
P13.3	Earth fault	0	3		2	703	0 = No action 1 = Alarm 2 = Fault: Stop function 3 = Fault: Coast
P13.4	Output Phase Fault	0	3		2	702	See 13.3
P13.5	Stall protection	0	3		0	709	See 13.3
P13.6	Under load protection	0	3		0	713	See 13.3
P13.7	Motor thermal protection	0	3		2	704	See 13.3

Table 18: Protections

Code	Parameter	Min	Max	Unit	Default	ID	Note
P13.8	Mtp:Ambient temperature	-20	100	°C	40	705	Environment temperature
P13.9	Mtp:Zero speed cooling	0.0	150.0	%	40.0	706	Cooling as % at 0 speed
P13.10	Mtp:Thermal time constant	1	200	min	Varies	707	Motor thermal time constant
P13.11	Stall Current	0.00	2.0 x I _{Nunit}	A	I _{Nunit}	710	For a stall stage to occur, the current must have exceeded this limit
P13.12	Stall time	0.00	300.00	s	15.00	711	Stall time limited
P13.13	Stall frequency	0.10	320.00	Hz	25.00	712	Stall min frequency
P13.14	UL:Field weakening load	10.0	150.0	%	50.0	714	Minimum torque at field weakening
P13.15	UL:Zero freq load	5.0	150.0	%	10.0	715	Minimum torque at f0
P13.16	UL:Time limit	1.0	300.0	s	20.0	716	This is the maximum time allowed for an underload state to exist
P13.17	Analogue Input low fault delay	0.0	10.0	s	0.5	1430	Delay time for analogue input low fault
P13.18	External fault	0	3		2	701	0 = No action 1 = Alarm 2 = Fault: Stop function 3 = Fault: Coast
P13.19	Fieldbus fault	0	4		3	733	See 13.1
P13.20	Preset alarm frequency	P3.1	P3.2	Hz	25.00	183	Frequency used when fault response is Alarm + preset Frequency
P13.21	Parameters edit lock	0	1		0	819	0 = Edit enabled 1 = Edit disabled
P13.22	Thermistor Fault	0	3		2	732	0 = No action 1 = Alarm 2 = Fault: Stop function 3 = Fault: Coast Hidden until an option board is connected
P13.23	FWD/REV conflict supervision	0	3		1	1463	See P13.3
P13.24	Temperature fault	0	3		0	740	See P13.3, hidden until an OPTBH board is connected

Table 18: Protections

Code	Parameter	Min	Max	Unit	Default	ID	Note
P13.25	Temperature fault input	1	7		1	739	Binary-coded selection of signals to use for alarm and fault triggering B0 = Temperature input 1 B1 = Temperature input 2 B2 = Temperature input 3 NOTE! Hidden until an OPTBH board is connected
P13.26	Temperature fault mode	0	2		2	743	0 = Not used 1 = Low limit 2 = High limit
P13.27	Temperature fault limit	-50.0/ 223.2	200.0/ 473.2		100.0	742	Temperature fault threshold, hidden until an OPTBH board is connected
P13.28	Input phase fault*	0	3		3	730	As parameter P13.3
P13.29	Motor temperature memory mode*	0	2		2	15521	0 = disabled 1 = constant mode 2 = last value mode

Table 18: Protections

NOTE!

* These parameters are only available in power SW FWP00001V026 included in FW01070V010 or later version.

NOTE! These parameters are shown, when **P17.2 = 0**.

5.16 Fault autoreset parameters (Control panel: Menu PAR -> P14)

Code	Parameter	Min	Max	Unit	Default	ID	Note
P14.1	Automatic Reset	0	1		0	731	0 = Disabled 1 = Enable
P14.2	Wait time	0.10	10.00	s	0.50	717	Waiting time after fault
P14.3	Trial time	0.00	60.00	s	30.00	718	Maximum time for trials
P14.4	Trials number	1	10		3	759	Maximum trials
P14.5	Restart Function	0	2		2	719	0 = Ramping 1 = Flying 2 = From Start Function

Table 19: Fault autoreset parameters

NOTE! These parameters are shown, when **P17.2 = 0**.

24-hour support +358 (0)201 212 575 • Email: vacon@vacon.com

5.17 PID control parameters (Control panel: Menu PAR -> P15)

Code	Parameter	Min	Max	Unit	Default	ID	Note
P15.1	Setpoint source selection	0	Varies		0	332	0 = Fixed setpoint % 1 = AI1 2 = AI2 3 = ProcessDataIn1 (0 - 100%) 4 = ProcessDataIn2 (0 - 100%) 5 = ProcessDataIn3 (0 - 100%) 6 = ProcessDataIn4 (0 - 100%) 7 = Pulse train/encoder 8 = AIE1 9 = Temperature input 1 10 = Temperature input 2 11 = Temperature input 3
P15.2	Fixed setpoint	0.0	100.0	%	50.0	167	Fixed setpoint
P15.3	Fixed setpoint 2	0.0	100.0	%	50.0	168	Alternative fixed setpoint, selectable with DI
P15.4	Feedback source selection	0	Varies		1	334	0 = AI1 1 = AI2 2 = ProcessDataIn1 (0 - 100%) 3 = ProcessDataIn2 (0 - 100%) 4 = ProcessDataIn3 (0 - 100%) 5 = ProcessDataIn4 (0 - 100%) 6 = AI2-AI1 7 = Pulse train / encoder 8 = AIE1 9 = Temperature input 1 10 = Temperature input 2 11 = Temperature input 3
P15.5	Feedback value minimum	0.0	50.0	%	0.0	336	Value at minimum signal
P15.6	Feedback value maximum	10.0	300.0	%	100.0	337	Value at maximum signal
P15.7	P gain	0.0	1000.0	%	100.0	118	Proportional gain
P15.8	I time	0.00	320.00	s	10.00	119	Integrative time

Table 20: PID control parameters

Code	Parameter	Min	Max	Unit	Default	ID	Note
P15.9	D time	0.00	10.00	s	0.00	132	Derivative time
P15.10	Error inversion	0	1		0	340	0 = Direct (Feedback < Setpoint -> Increase PID output) 1 = Inverted (Feedback > Setpoint -> Decrease PID output)
P15.11	Sleep minimum frequency	0.00	P3.2	Hz	25.00	1016	Drive goes to sleep mode when the output frequency stays below this limit for a time greater than that defined by parameter Sleep delay
P15.12	Sleep delay	0	3600	s	30	1017	Delay for enter sleep
P15.13	Wake up error	0.0	100.0	%	5.0	1018	Threshold for exit sleep
P15.14	Sleep setpoint boost	0.0	50.0	%	10.0	1071	Referred to setpoint
P15.15	Setpoint boost time	0	60	s	10	1072	Boost time after P15.12
P15.16	Sleep maximum loss	0.0	50.0	%	5.0	1509	Referred to feedback value after boost
P15.17	Sleep loss check time	1	300	s	30	1510	After boost time P15.15
P15.18	Process unit source select	0	6		0	1513	0 = PID feedback value 1 = Output frequency 2 = Motor speed 3 = Motor torque 4 = Motor power 5 = Motor current 6 = Pulse Train / Encoder
P15.19	Process unit decimal digits	0	3		1	1035	Decimals on display
P15.20	Process unit minimum value	0.0	P15.21		0.0	1033	Process min value
P15.21	Process unit maximum value	P15.20	3200.0		100.0	1034	Process max value

Table 20: PID control parameters

Code	Parameter	Min	Max	Unit	Default	ID	Note
P15.22	Temperature min value	-50.0/ 223.2	P15.23		0.0	1706	Temperature min value for PID and frequency reference scale, hidden until an OPTBH board is connected
P15.23	Temperature max value	P15.22	200.0/ 473.2		100.0	1707	Temperature max value for PID and frequency reference scale, hidden until an OPTBH board is connected

Table 20: PID control parameters

NOTE! These parameters are shown, when P17.2 = 0.

5.18 Motor c (Control panel: Menu PAR -> P16)

Code	Parameter	Min	Max	Unit	Default	ID	Note
P16.1	Motor Preheat Function	0	2		0	1225	0 = Not used 1 = Always in stop state 2 = Controlled by digital input
P16.2	Motor Preheat Current	0	0.5 x I _{Nunit}	A	0	1227	DC current for preheating of motor and drive in stop state. Active in stop state or by digital input while in stop state.

Table 21: Motor Preheat

5.19 Easy usage menu (Control panel: Menu PAR -> P17)

Code	Parameter	Min	Max	Unit	Default	ID	Note
P17.1	Application Type	0	3		0	540	0 = Basic 1 = Pump 2 = Fan drive 3 = High Torque NOTE! Visible only when Startup wizard is active.
P17.2	Parameter conceal	0	1		1	115	0 = All parameters visible 1 = Only quick setup parameter group visible
P17.3	Temperature unit	0	1		0	1197	0 = Celsius 1 = Kelvin NOTE! Hidden until an OPTBH board is connected

Code	Parameter	Min	Max	Unit	Default	ID	Note
P17.4	Application access password*	0	3000 0		0	2362	Input the right password could review parameter group 18.

Table 22: Easy usage menu parameters

NOTE!

* These parameters are only available in power SW FWP00001V026 included in FW01070V010 or later version.

5.20 System parameters

Code	Parameter	Min	Max	Default	ID	Note
Software information (MENU SYS->V1)						
V1.1	API SW ID				2314	
V1.2	API SW version				835	
V1.3	Power SW ID				2315	
V1.4	Power SW version				834	
V1.5	Application ID				837	
V1.6	Application revision				838	
V1.7	System load				839	
When no field bus Option Board or no OPT-BH Board has been installed, the Modbus comm. parameters are as follows						
V2.1	Communication status				808	Status of Modbus communication. Format: xx.yyy where xx = 0 - 64 (Number of error messages) yyy = 0 - 999 (Number of good messages)
P2.2	Fieldbus protocol	0	1	0	809	0 = Not used 1 = Modbus used
P2.3	Slave address	1	255	1	810	Default setting: None parity, 1 stop bit

Table 23: System parameters

Code	Parameter	Min	Max	Default	ID	Note
P2.4	Baud rate	0	8	5	811	0 = 300 1 = 600 2 = 1200 3 = 2400 4 = 4800 5 = 9600 6 = 19200 7 = 38400 8 = 57600
P2.6	Parity type	0	2	0	813	0 = None 1 = Even 2 = Odd The Stop Bit is 2-bit When Parity type is 0 = None; The Stop Bit is 1-bit When Parity type is 1 = Even or 2 = Odd
P2.7	Communication time out	0	255	10	814	0 = Not used 1 = 1 sec 2 = 2 secs, etc
P2.8	Reset communication status	0	1	0	815	
When Canopen E6 board has been installed, the comm. parameters are as follows						
V2.1	Canopen communication status				14004	0 = Initialising 4 = Stopped 5 = Operational 6 = Pre_Operational 7 = Reset_Application 8 = Reset_Comm 9 = Unknow
P2.2	Canopen operation mode	1	2	1	14003	1 = Driver Profile 2 = Bypass
P2.3	Canopen Node ID	1	127	1	14001	

Table 23: System parameters

Code	Parameter	Min	Max	Default	ID	Note
P2.4	Canopen baud rate	3	8	6	14002	3 = 50 kbaud 4 = 100 kbaud 5 = 125 kbaud 6 = 250 kbaud 7 = 500 kbaud 8 = 1000 kbaud
When DeviceNet E7 board has been installed, the comm. parameters are as follows						
V2.1	Communication status				14014	Status of Modbus communication. Format: XXXX.Y, X = DeviceNet msg counter Y = DeviceNet status 0 = Non-existent or no bus power 1 = Configuring state 2 = Established 3 = Timeout
P2.2	Output assembly type	20	111	21	14012	20, 21, 23, 25, 101, 111
P2.3	MAC ID	0	63	63	14010	
P2.4	Baud rate	1	3	1	14011	1 = 125 kbit/s 2 = 250 kbit/s 3 = 500 kbit/s
P2.5	Input assembly type	70	117	71	14013	70, 71, 73, 75, 107, 117
When ProfidBus E3/E5 board has been installed, the comm. parameters are as follows						
V2.1	Communication status				14022	
V2.2	Fieldbus protocol status				14023	
V2.3	Active protocol				14024	
V2.4	Active baud rate				14025	
V2.5	Telegram type				14027	
P2.6	Operate mode	1	3	1	14021	1 = Profidrive 2 = Bypass 3 = Echo
P2.7	Slave address	2	126	126	14020	
When ModbusTCP & ProfinetIO & Ethernet/IP E9 board has been installed, the comm.Parameters are as follows						
V2.1	IP Part1	1	233		14232	current IP Address Part1

Table 23: System parameters

Code	Parameter	Min	Max	Default	ID	Note
V2.2	IP Part2	0	255		14233	current IP Address Part2
V2.3	IP Part3	0	255		14234	current IP Address Part3
V2.4	IP Part4	0	255		14235	current IP Address Part4
V2.5	Subnet Mask P1	0	255		14236	current Subnet Mask Part1
V2.6	Subnet Mask P2	0	255		14237	current Subnet Mask Part2
V2.7	Subnet Mask P3	0	255		14238	current Subnet Mask Part3
V2.8	Subnet Mask P4	0	255		14239	current Subnet Mask Part4
V2.9	Default GW P1	0	255		14240	current Default Gateway Part1
V2.10	Default GW P2	0	255		14241	current Default Gateway Part2
V2.11	Default GW P3	0	255		14242	current Default Gateway Part3
V2.12	Default GW P4	0	255		14243	current Default Gateway Part4
V2.13	FB Protocol Status				14244	Initializing (1), Stopped (2), Operational (3), Faulted (4)
V2.14	Communication Status				14245	0-64 Number of messages with errors, 0-999 Number of messages without communication errors
V2.15	Drive control word				14246	Control word in drive format (hex)
V2.16	Drive Status word				14247	Status word in drive format (hex)
V2.17	Profile control word				14248	Control word in protocol format (hex)
V2.18	Profile status word				14249	Status word in protocol format (hex)
V2.19	EIP Product Code				14255	Currently used EtherNet/IP Product

Table 23: System parameters

Code	Parameter	Min	Max	Default	ID	Note
P2.19	Protocol	1	2	1	14230	Active Protocol. 1= ModbusTCP, 2= ProfinetIO 3=EtherNet/IP
P2.20	IP Address Mode	1	2	2	14231	IP mode. 1=DHCP, 2=fixed. When in DHCP mode,the IP address cannot be changed manually
P2.21	IP Part1	1	223	192	14180	IP Address Part1
P2.22	IP Part2	0	255	168	14181	IP Address Part2
P2.23	IP Part3	0	255	0	14182	IP Address Part3
P2.24	IP Part4	0	255	10	14183	IP Address Part4
P2.25	Subnet Mask P1	0	255	255	14184	Subnet Mask Part 1
P2.26	Subnet Mask P2	0	255	255	14185	Subnet Mask Part 2
P2.27	Subnet Mask P3	0	255	0	14186	Subnet Mask Part 3
P2.28	Subnet Mask P4	0	255	0	14187	Subnet Mask Part 4
P2.29	Default GW P1	0	255	192	14188	Default Gateway Part1
P2.30	Default GW P2	0	255	168	14189	Default Gateway Part2
P2.31	Default GW P3	0	255	0	14190	Default Gateway Part3
P2.32	Default GW P4	0	255	1	14191	Default Gateway Part4
P2.33	Comm.Timeout	0	65535	10	14200	Comm.Timeout
P2.35	EIP Output Instance	1	8	2	14251	Ethernet I/O Output assembly instance. 1=20; 2=21; 3=23; 4=25; 5=101; 6=111; 7=128; 8=131.
P2.36	EIP Input Instance	1	8	2	14252	Ethernet I/O Input assembly instance. 1=70; 2=71; 3=73; 4=75; 5=107; 6=117; 7=127; 8=137.

Table 23: System parameters

Code	Parameter	Min	Max	Default	ID	Note
P2.38	EIP Product Code Offset	0	99	0	14254	Ethernet/IP product code offset. User can add value between 0 and 99 to product code base value. Final product code can be viewed from monitorin-menu.
P2.41	Modbus Unit Identifier	1	255	255	14257	Modbus unit identifier. 1 -247 Slave address; 255= Accept all
When OPT-BH board has been installed, the comm. parameters are as follows						
P2.1	Sensor 1 type	0	6	0	14072	0 = No Sensor 1 = PT100 2 = PT1000 3 = Ni1000 4 = KTY84 5 = 2 x PT100 6 = 3 x PT100
P2.2	Sensor 2 type	0	6	0	14073	0 = No Sensor 1 = PT100 2 = PT1000 3 = Ni1000 4 = KTY84 5 = 2 x PT100 6 = 3 x PT100
P2.3	Sensor 3 type	0	6	0	14074	0 = No Sensor 1 = PT100 2 = PT1000 3 = Ni1000 4 = KTY84 5 = 2 x PT100 6 = 3 x PT100
When OPT-EC board has been installed ,the comm. Parameters are as follows						
V2.1	version number			0		Version number of the board software
V2.2	Board status			0		State of the OPTEC board application
Other information						
V3.1	MWh counter				827	Million Watt Hour
V3.2	Power on days				828	

Table 23: System parameters

Code	Parameter	Min	Max	Default	ID	Note
V3.3	Power on hours				829	
V3.4	Run counter: Days				840	
V3.5	Run counter: Hours				841	
V3.6	Fault counter				842	
V3.7	Panel parameter set status monitor					Hidden when connect with PC.
P4.2	Restore factory defaults	0	1	0	831	1 = Restores factory defaults for all parameters
P4.3	Password	0000	9999	0000	832	
P4.4	Time for panel and lcd backlight active	0	99	5	833	NOTE! Backlight active time; [0->Off; 1-60->1-60min; >=61-> Always On]
P4.5	Save parameter set to panel	0	1	0		Hidden when connect with PC.
P4.6	Restore parameter set from panel	0	1	0		Hidden when connect with PC.
F5.x	Active Fault menu					
F6.x	Fault History menu					

Table 23: System parameters

6. FAULT TRACING

Fault code	Fault name	Fault code	Fault name
1	Overcurrent	27	Back EMF protection
2	Overvoltage	29	Thermistor fault
3	Earth fault	34	Internal bus communication
8	System fault	35	Application fault
9	Undervoltage	41	IGBT Overtemperature
10	Input phase fault	50	Analogue input select 20% - 100% (selected signal range 4 to 20 mA or 2 to 10 V)
11	Output phase fault	51	External fault
13	Frequency converter undertemperature	52	Door Panel fault
14	Frequency converter overtemperature	53	Fieldbus fault
15	Motor stalled	54	Slot fault
16	Motor overtemperature	55	Wrong run fault (FWD/REV conflict)
17	Motor underload	57	Identification fault
22	EEPROM checksum fault	63	Quick Stop
25	Microcontroller watchdog fault	111	Temperature fault

Table 24: Fault codes. See User Manual for detailed fault descriptions.

7. GENERAL DATA

Dimensions and weight	Frame	Height(mm)		Width(mm)		Depth (mm)		Weight (kg)	
		mm	inch	mm	inch	mm	inch	kg	lb.
	MI1	157	6.2	66	2.6	98	3.9	0.5	1.1
	MI2	195	7.7	90	3.5	102	4	0.7	1.5
	MI3	262	10.3	100	3.9	109	4.3	1	2.2
	MI4	370	14.6	165	6.5	165	6.5	8	17.6
	MI5	414	16.3	165	6.5	202	8	10	22
Supply network	Networks	Vacon 20 units with other than EMC4 filter combinations cannot be used on delta power networks (corner grounded)							
	Short circuit current	Maximum short circuit current has to be < 50 kA, For MI4 without DC-choke, maximum short circuit current has to be < 2.3 kA, for MI5 without DC-choke, maximum short circuit current has to be < 3.8 kA							
Motor connection	Output voltage	0 - U_{in}							
	Output current	Continuous rated current I_N at ambient temperature max +50 °C (depends on the unit size), overload $1.5 \times I_N$ max 1 min / 10 min							
Control connection	Digital input	Positive, Logic1: 18...+30V, Logic0: 0...5V; Negative, Logic1: 0...10V, Logic0: 18...30V; $R_i = 10K\Omega$ (floating)							
	Analogue input voltage	0...+10V, $R_i = 250K\Omega$							
	Analogue input current	0(4)...20mA, $R_i \leq 250\Omega$							
	Analogue output	0...10V, $R_L \geq 1K\Omega$; 0(4)...20mA, $R_L \leq 500\Omega$, Selectable through microswitch							
	Digital output	Open collector, max. load 35V/50mA (floating)							
	Relay output	Switching load: 250Vac/3A, 24V DC 3A							
	Auxiliary voltage	$\pm 20\%$, max. load 50mA							
Ambient conditions	Ambient operating temperature	-10 °C (no frost)...+40 / 50 °C (depends on the unit size): rated load-ability I_N Side by side installation for MI1-3 it is always 40 °C; For IP21/ Nema1 option in MI1-3 the maximum temperature is also 40 °C							
	Storage temperature	-40 °C...+70 °C							
	Relative humidity	0...95% RH, non-condensing, non-corrosive, no dripping water							
	Altitude	100% load capacity (no derating) up to 1000 m. 1% derating for each 100 m above 1000 m; max 2000 m							
	Enclosure class	IP20 / IP21 / Nema1 for MI1-3, IP21/Nema 1 for MI4-5							
	Pollution degree	PD2							

EMC	Immunity	Complies with EN50082-1, -2, EN61800-3
	Emissions(See detailed descriptions in Vacon 20 User Manual at: http://drives.danfoss.com/knowledge-center/technical-documentation/)	230V : Complies with EMC category C2; With an internal RFI filter. MI4 and 5 complies C2 with an optional DC choke and CM choke. 400V: Complies with EMC category C2; With an internal RFI filter MI4 and 5 complies C2 with an optional DC choke and CM choke. Both: No EMC emission protection (Vacon level N): Without RFI filter
Standards		For EMC: EN61800-3, For safety: UL508C, EN61800-5
Certificates and manufacturer's declarations of conformity		For safety: CE, UL, cUL, KC For EMC: CE, KC (see unit nameplate for more detailed approvals)

	Frame	Fuse [A]	Mains cable Cu (mm ²)	Terminal cable min-max (mm ²)		
				Main	Earth	Control and relay
Cable and fuse requirements (See detailed data in Vacon 20 User Manual at: www.vacon.com) 380 - 480 V, 3~ 208 - 240 V, 3~	MI1	6	3*1.5+1.5	1.5-4		0.5-1.5
	MI2	10		1.5-4		
	MI3	20		1.5-6		
	MI4	20 25 40 (20 and 40 is only for 208 - 240 V, 3~)	3*6+6	1-10Cu	1-10	
		MI5	40	3*10+10	2.5-50 Cu / Al	
115 V, 1~	MI2	20	2*2.5+2.5	1.5-4		
	MI3	32	2*6+6			
208 - 240, 1~	MI1	10	2*1.5+1.5	1.5-6		
	MI2	20	2*2.5+2.5			
	MI3	32	2*6+6			
600 V	MI3	6	3*1.5+1.5	1.5-4		
	MI3	10				
	MI3	20	3*2.5+2.5	1.5-6		

- With above-mentioned fuses, the drive can be connected to power supply the short circuit current of which is max 50 kA
- Use cables with heat resistance of at least +70 °C.
- The fuses function also as cable overload protection.
- These instructions apply only to cases with one motor and one cable connection from the frequency converter to the motor.
- To fulfil standard EN61800-5-1, the protective conductor should be **at least 10 mm² Cu or 16 mm² Al**. Another possibility is to use an additional protective conductor of at least the same size as the original one.

Vacon 20 power ratings

Mains voltage 208 - 240 V, 50 / 60 Hz, 1~ series							
Fre- quency converter type	Rated loadability		Motor shaft power		Nominal input current [A]	Mechanical size	Weight (kg)
	100% contin. current I _N [A]	150% over- load current [A]	P [HP]	P [KW]			
0001	1.7	2.6	0.33	0.25	4.2	M11	0.55
0002	2.4	3.6	0.5	0.37	5.7	M11	0.55
0003	2.8	4.2	0.75	0.55	6.6	M11	0.55
0004	3.7	5.6	1	0.75	8.3	M12	0.7
0005	4.8	7.2	1.5	1.1	11.2	M12	0.7
0007	7	10.5	2	1.5	14.1	M12	0.7
0009*	9.6	14.4	3	2.2	22.1	M13	0.99

Table 25: Vacon 20 power ratings, 208 - 240 V

* The maximum ambient operating temperature of this drive is 40 °C!

Mains voltage 208 - 240 V, 50 / 60 Hz, 3~ series							
Fre- quency converter type	Rated loadability		Motor shaft power		Nominal input current [A]	Mechanical size	Weight (kg)
	100% contin. current I _N [A]	150% over- load current [A]	P [HP]	P [KW]			
0001	1.7	2.6	0.33	0.25	2.7	M11	0.55
0002	2.4	3.6	0.5	0.37	3.5	M11	0.55
0003	2.8	4.2	0.75	0.55	3.8	M11	0.55
0004	3.7	5.6	1	0.75	4.3	M12	0.7
0005	4.8	7.2	1.5	1.1	6.8	M12	0.7
0007*	7	10.5	2	1.5	8.4	M12	0.7
0011*	11	16.5	3	2.2	13.4	M13	0.99
0012	12.5	18.8	4	3	14.2	M14	9
0017	17.5	26.3	5	4	20.6	M14	9
0025	25	37.5	7.5	5.5	30.3	M14	9
0031	31	46.5	10	7.5	36.6	M15	11
0038	38	57	15	11	44.6	M15	11

Table 26: Vacon 20 power ratings, 208 - 240 V, 3~

*The maximum ambient operating temperature of this drive is +40°C !

Mains voltage 115 V, 50 / 60 Hz, 1~ series							
Fre- quency converter type	Rated loadability		Motor shaft power		Nominal input current [A]	Mechanical size	Weight [Kg]
	100% contin. current I_N [A]	150% over- load current [A]	P [HP]	P [KW]			
0001	1.7	2.6	0.33	0.25	9.2	MI2	0.7
0002	2.4	3.6	0.5	0.37	11.6	MI2	0.7
0003	2.8	4.2	0.75	0.55	12.4	MI2	0.7
0004	3.7	5.6	1	0.75	15	MI2	0.7
0005	4.8	7.2	1.5	1.1	16.5	MI3	0.99

Table 27: Vacon 20 power ratings, 115 V, 1~

Mains voltage 380 - 480 V, 50 / 60 Hz, 3~ series							
Fre- quency converter type	Rated loadability		Motor shaft power		Nominal input current [A]	Mechanical size	Weight [kg]
	100% contin. current I_N [A]	150% over- load current [A]	P [HP]	P [KW]			
0001	1.3	2	0.5	0.37	2.2	MI1	0.55
0002	1.9	2.9	0.75	0.55	2.8	MI1	0.55
0003	2.4	3.6	1	0.75	3.2	MI1	0.55
0004	3.3	5	1.5	1.1	4	MI2	0.7
0005	4.3	6.5	2	1.5	5.6	MI2	0.7
0006	5.6	8.4	3	2.2	7.3	MI2	0.7
0008	7.6	11.4	4	3	9.6	MI3	0.99
0009	9	13.5	5	4	11.5	MI3	0.99
0012	12	18	7.5	5.5	14.9	MI3	0.99
0016	16	24	10	7.5	17.1	MI4	9
0023	23	34.5	15	11	25.5	MI4	9
0031	31	46.5	20	15	33	MI5	11
0038	38	57	25	18.5	41.7	MI5	11

Table 28: Vacon 20 power ratings, 380 - 480 V

Mains voltage 600 V, 50 / 60 Hz, 3~ series							
Fre- quency converter type	Rated loadability		Motor shaft power		Nominal input current [A]	Mechanical size	Weight [kg]
	100% contin. current I _N [A]	150% over- load current [A]	P [HP]	P [KW]			
0002	1.7	2.6	1	0.75	2	MI3	0.99
0003	2.7	4.2	2	1.5	3.6	MI3	0.99
0004	3.9	5.9	3	2.2	5	MI3	0.99
0006	6.1	9.2	5	4	7.6	MI3	0.99
0009	9	13.5	7.5	5.5	10.4	MI3	0.99

Table 29: Vacon 20 power ratings, 600 V

Note 1: The input currents are calculated values with 100 kVA line transformer supply.

Note 2: For PM motor, please select the drive power rating according to motor shaft power, not rated current.

Quick Modbus setup

1	A: Select Fieldbus as remote control place: P2.1 to 1 - Fieldbus, P3.3 to 3 - Fieldbus B: Set Modbus RTU protocol to "ON": SYS P2.2 to 1 - Modbus
2	A. Set Control Word to "0" (2001) B. Set Control Word to "1" (2001) C. Frequency converter status is RUN D. Set Reference value to "5000" (50.00%) (2003) E. Actual Speed is 5000 (25.00 Hz if MinFreq is 0.00 Hz and MaxFreq is 50.00 Hz) F. Set Control Word to "0" (2001) G. Frequency converter status is STOP

VACON®

www.danfoss.com

Vacon Ltd
Member of the Danfoss Group
Runsorintie 7
65380 Vaasa
Finland

Document ID:



Rev. H1